

Construction: BFC canopy shall be Type 430 stainless steel with a #4 finish where shows. All seams, joints and penetrations of the hood that directs and captures grease-laden vapors and particles of combustion shall have a liquid-tight continuous external weld in accordance with NFPA #96.

Mounting: BFC canopy shall be wall mounting type with a minimum of four connections for hanger rods. Mounting brackets shall include 3/8" nuts welded on center at the factory to allow for hanger rod connection by others.

Filters: BFC canopy shall be furnished with U.L. classified baffle filters, supplied in size and quantity as required by the quantity of exhaust. The filters shall extend the full length of the hood and the filler panels shall not be more than 6" in width. The grease gutter shall be an integral part of the hood and have a minimum 1/8" per foot slope with an exposed, easily removable grease cup for cleaning. Grease cup capacity shall not exceed one U.S. gallon.

Lights: BFC canopy shall be furnished with U.L. incandescent light fixtures and globes shall be installed and pre-wired to a junction box. The light fixtures shall be installed with a maximum of 4'0" spacing on center and allow up to a 100 watt standard light bulb.

Listings: BFC canopy shall be UL 710 Listed as "Exhaust Hood Without Exhaust Damper", NSF Listed and built in accordance with NFPA 96. BFC canopy is listed for 400°F cooking surfaces at 185 CFM/ft and 600°F cooking surfaces at 243 CFM/ft.



Built in accordance to NFPA #96



PREMIUM AIR SYSTEMS
 1051 NAUGHTON, TROY, MI 48083
 TEL: (248) 680-8800 FAX: (248) 680-8808
 KENTUCKY FABRICATION PLANT
 TEL: (270) 864-5785 FAX: (270) 864-9265

www.premiumair.net

JOB NAME:

ADDRESS:

**BFC SERIES
 BOX FRONT CANOPY
 DESCRIPTION:
 57" DEEP CANOPY
 LOW EXHAUST
 STYLE HOOD**



LISTED
 EXHAUST HOODS WITHOUT
 EXHAUST DAMPERS
 8R16

DRAWING DATE: 10/21/02
 DRAWN BY: PAS-MI
 DRAWING SCALE: 1/2" = 1'

Front View

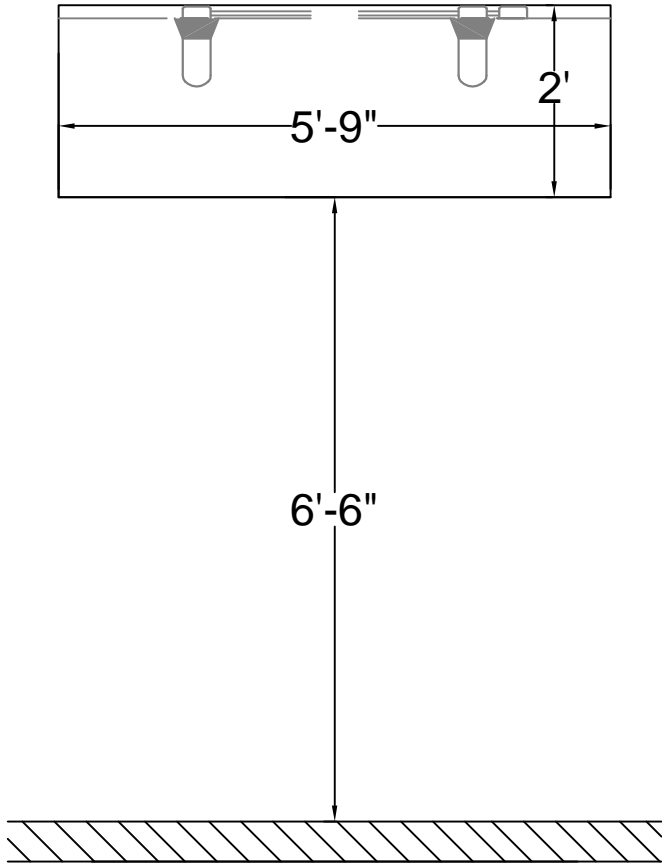

Plan View with 3" insulated rear spacer

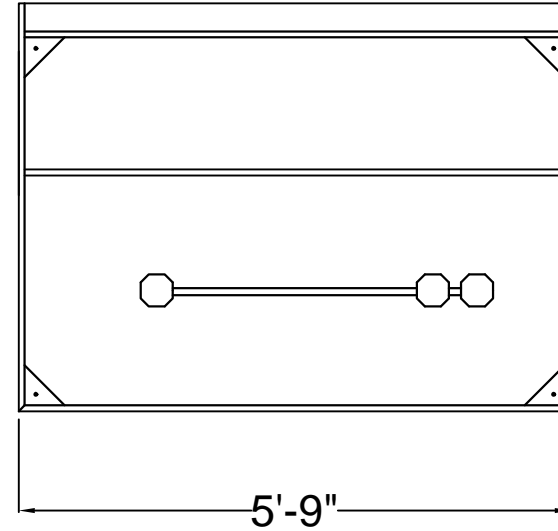

Hood Depth - 6" Overhang Required

- 51"
- 57"
- 63"
- Other- Specify _____"

Built in accordance to NFPA #96

End Curtains (recommended)

- Right
- Left
- None

Insulated Side Spacer

- Right
- Left
- Ohio Location

Stainless Steel Wall Panel

- Yes No
- Quilted Pattern

Hood Enclosure

- Yes No
- Ceiling Hgt. ____' ____"

Add 6" overhang to side without an end curtain



PREMIUM AIR SYSTEMS
 1051 NAUGHTON, TROY, MI 48083
 TEL: (248) 680-8800 FAX: (248) 680-8808
 KENTUCKY FABRICATION PLANT
 TEL: (270) 864-5785 FAX: (270) 864-9265

www.premiumair.net

JOB NAME:

ADDRESS:

**BFC SERIES
 BOX FRONT CANOPY
 DESCRIPTION:
 69" X DEPTH X 24"
 LOW EXHAUST
 STYLE HOOD**



LISTED
 EXHAUST HOODS WITHOUT
 EXHAUST DAMPERS
 8R16

DRAWING DATE: 10/21/02
 DRAWN BY: PAS-MI
 DRAWING SCALE: 1/2" = 1'