

Construction: LPC canopy shall be Type 430 stainless steel with a #4 finish where shows. All seams, joints and penetrations of the hood that directs and captures grease-laden vapors and particles of combustion shall have a liquid-tight continuous external weld in accordance with NFPA #96.

Mounting: LPC canopy shall be wall mounting type with a top mounting bracket provided.

Filters: LPC canopy shall be furnished with U.L. classified baffle filters, supplied in size and quantity as required by the quantity of exhaust. The filters shall extend the full length of the hood and the filler panels shall not be more than 6" in width. The grease gutter shall be an integral part of the hood and have a minimum 1/8" per foot slope with an exposed, easily removable grease cup for cleaning. Grease cup capacity shall not exceed one U.S. gallon.

Lights: LPC canopy is not furnished with U.L. incandescent light fixtures.

Listings: LPC canopy shall be UL 710 Listed as "Exhaust Hood Without Exhaust Damper", NSF Listed and built in accordance with NFPA 96. LPC canopy is listed for 400°F cooking surfaces at 187 CFM/ft and 600°F cooking surfaces at 243 CFM/ft.

Side View

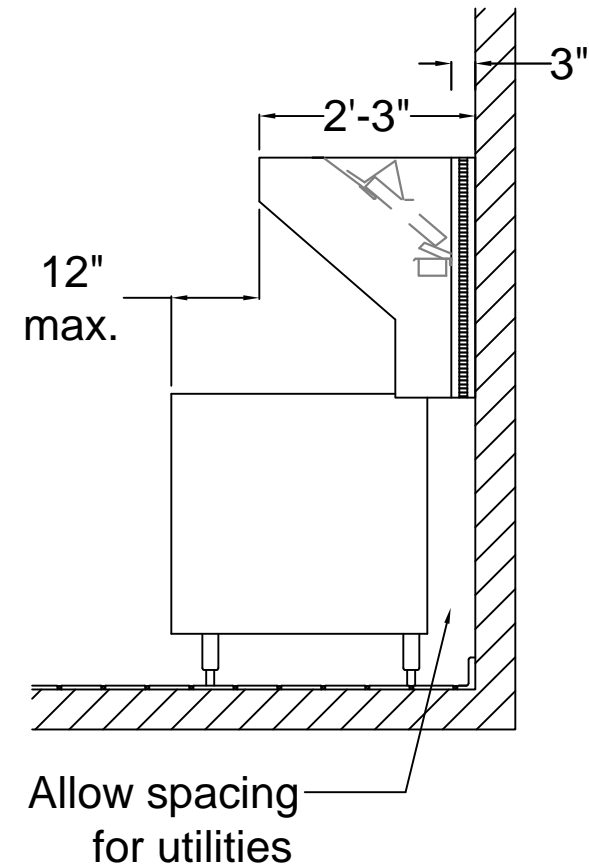

Built in accordance to NFPA #96



PREMIUM AIR SYSTEMS
1051 NAUGHTON, TROY, MI 48083
TEL: (248) 680-8800 FAX: (248) 680-8808
KENTUCKY FABRICATION PLANT
TEL: (270) 864-5785 FAX: (270) 864-9265

www.premiumair.net

JOB NAME:

ADDRESS:

**LPC SERIES
LOW PROFILE CANOPY
DESCRIPTION:
SIDEVIEW
LOW EXHAUST
STYLE HOOD**



**LISTED
EXHAUST HOODS WITHOUT
EXHAUST DAMPERS
8R16**

**DRAWING DATE: 10/21/02
DRAWN BY: PAS-MI
DRAWING SCALE: 1/2" = 1'**

Front View

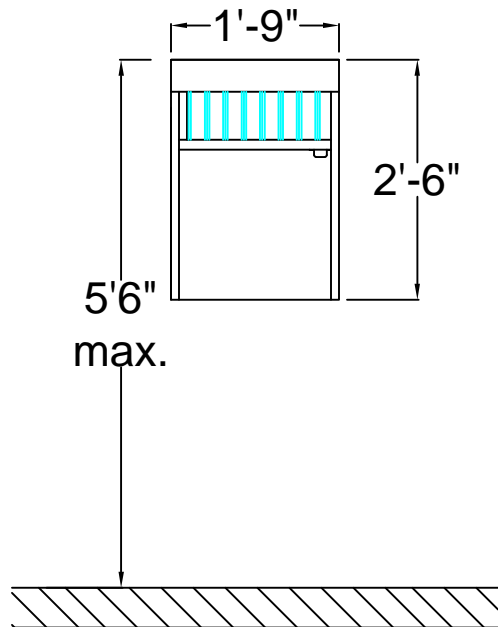

Plan View with 3" insulated rear spacer

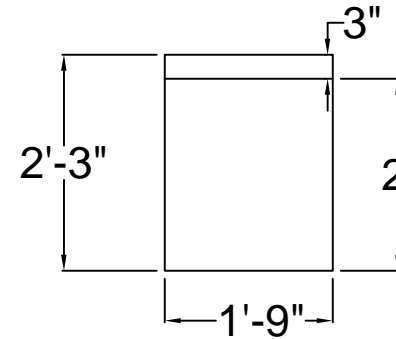

Built in accordance to NFPA #96

Insulated Side Spacer

- Right
- Left
- Ohio Location

Stainless Steel Wall Panel

- Yes No
- Quilted Pattern

Hood Enclosure

- Yes No
- Ceiling Hgt. ___' ___"



PREMIUM AIR SYSTEMS

1051 NAUGHTON, TROY, MI 48083
 TEL: (248) 680-8800 FAX: (248) 680-8808
 KENTUCKY FABRICATION PLANT
 TEL: (270) 864-5785 FAX: (270) 864-9265

www.premiumair.net

JOB NAME:

ADDRESS:

LPC SERIES
LOW PROFILE CANOPY
DESCRIPTION:
 21" X 27" X 30"
 LOW EXHAUST
 STYLE HOOD



LISTED
 EXHAUST HOODS WITHOUT
 EXHAUST DAMPERS
 8R16

DRAWING DATE: 10/21/02
 DRAWN BY: PAS-MI
 DRAWING SCALE: 1/2" = 1'