

**Construction:** LPC canopy shall be Type 430 stainless steel with a #4 finish where shows. All seams, joints and penetrations of the hood that directs and captures grease-laden vapors and particles of combustion shall have a liquid-tight continuous external weld in accordance with NFPA #96.

**Mounting:** LPC canopy shall be wall mounting type with a top mounting bracket provided.

**Filters:** LPC canopy shall be furnished with U.L. classified baffle filters, supplied in size and quantity as required by the quantity of exhaust. The filters shall extend the full length of the hood and the filler panels shall not be more than 6" in width. The grease gutter shall be an integral part of the hood and have a minimum 1/8" per foot slope with an exposed, easily removable grease cup for cleaning. Grease cup capacity shall not exceed one U.S. gallon.

**Lights:** LPC canopy is not furnished with U.L. incandescent light fixtures.

**Listings:** LPC canopy shall be UL 710 Listed as "Exhaust Hood Without Exhaust Damper", NSF Listed and built in accordance with NFPA 96. LPC canopy is listed for 400°F cooking surfaces at 187 CFM/ft and 600°F cooking surfaces at 243 CFM/ft.

Side View

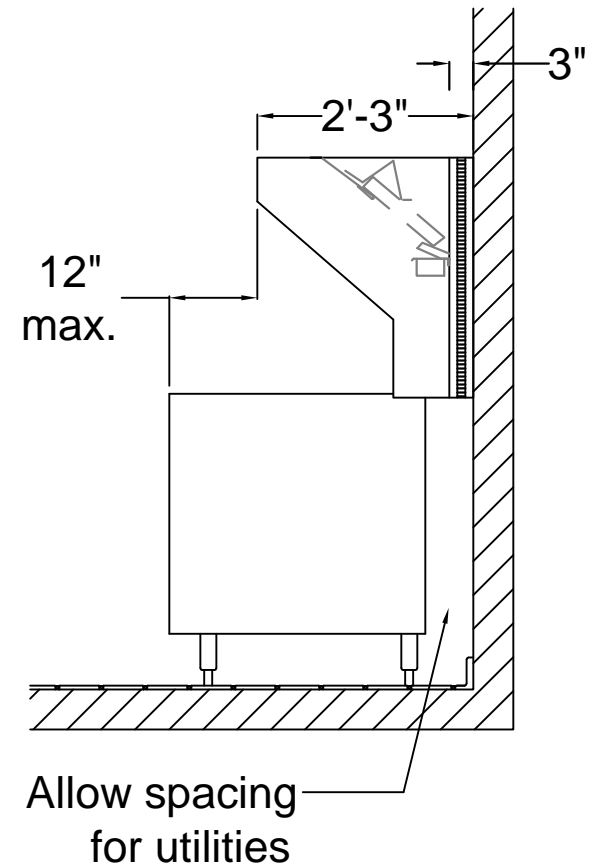

Built in accordance to NFPA #96



**PREMIUM AIR SYSTEMS**

1051 NAUGHTON, TROY, MI 48083  
TEL: (248) 680-8800 FAX: (248) 680-8808  
KENTUCKY FABRICATION PLANT  
TEL: (270) 864-5785 FAX: (270) 864-9265

www.premiumair.net

JOB NAME:

ADDRESS:

**LPC SERIES  
LOW PROFILE CANOPY  
DESCRIPTION:  
SIDEVIEW  
LOW EXHAUST  
STYLE HOOD**



**LISTED  
EXHAUST HOODS WITHOUT  
EXHAUST DAMPERS  
8R16**

**DRAWING DATE: 10/21/02  
DRAWN BY: PAS-MI  
DRAWING SCALE: 1/2" = 1'**

Front View

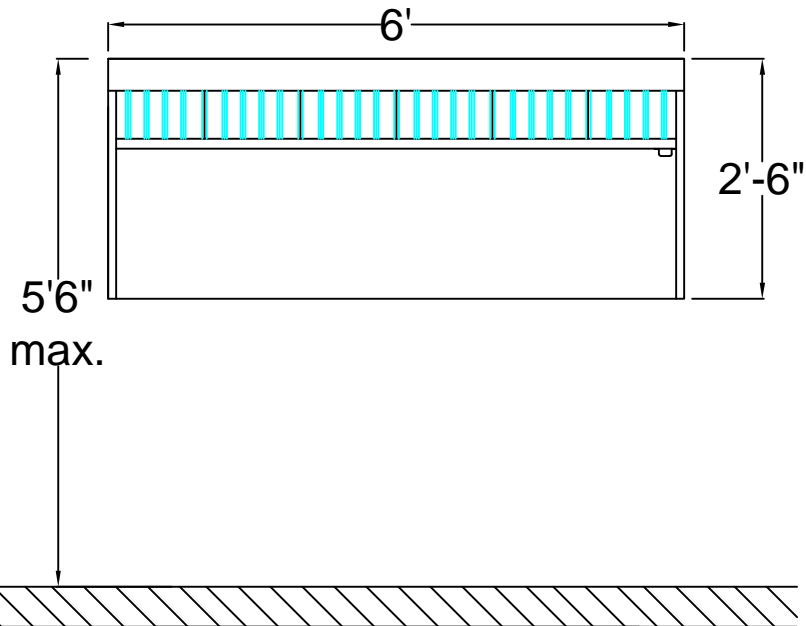

Plan View with 3" insulated rear spacer

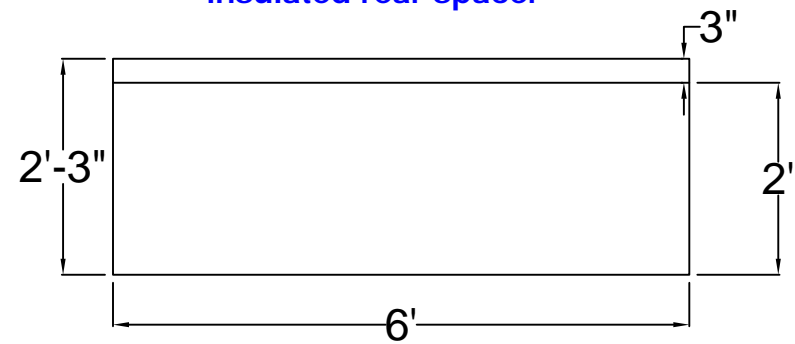

Built in accordance to NFPA #96

Insulated Side Spacer

- Right
- Left
- Ohio Location

Stainless Steel Wall Panel

- Yes  No
- Quilted Pattern

Hood Enclosure

- Yes  No
- Ceiling Hgt. \_\_\_' \_\_\_"



**PREMIUM AIR SYSTEMS**

1051 NAUGHTON, TROY, MI 48083  
 TEL: (248) 680-8800 FAX: (248) 680-8808  
 KENTUCKY FABRICATION PLANT  
 TEL: (270) 864-5785 FAX: (270) 864-9265

www.premiumair.net

JOB NAME:

ADDRESS:

**LPC SERIES**  
**LOW PROFILE CANOPY**  
**DESCRIPTION:**  
**72" X 27" X 30"**  
**LOW EXHAUST**  
**STYLE HOOD**



LISTED  
 EXHAUST HOODS WITHOUT  
 EXHAUST DAMPERS  
 8R16

DRAWING DATE: 10/21/02  
 DRAWN BY: PAS-MI  
 DRAWING SCALE: 1/2" = 1'